

NaturalPoint®

MotionBuilder Plugin User's Guide

Version 2.4
April 8, 2011



NaturalPoint Corporation
33872 SE Eastgate Circle
Corvallis OR 97339

Autodesk®
Authorized Developer

Copyright © 2004-2011 **NaturalPoint Corporation**. All rights reserved.
NaturalPoint Publication Number: P-OT-055
Printed in the US.

NaturalPoint Proprietary

All data and information contained in or disclosed by this document is confidential and proprietary information of **NaturalPoint Corporation** and all rights therein are expressly reserved. By accepting this material the recipient agrees that this material and the information contained therein is held in confidence and in trust and will not be used, copied, reproduced in whole or in part, nor its contents revealed in any manner to others without the express written permission of **NaturalPoint Corporation**. Information in this document is preliminary and subject to change and does not represent a commitment on the part of **NaturalPoint Corporation**.

TABLE OF CONTENTS

Table Of Contents	3
MotionBuilder Plugin Overview	5
OptiTrack Optical Device.....	6
Device Panel.....	7
Step-By-Step Usage Example	9
Recording Optical Data	11
Playing Back Recorded Data.....	11
MotionBuilder Actor / Character Setup	11
Actor Setup (Mocap Marker Data -> MotionBuilder “Actor”)	12
Character Setup (MotionBuilder Actor -> Character)	13
Virtual Camera Device (Insight VCS)	14
Installation and Licensing.....	16
Supported Platforms.....	16
Installation	16
Licensing.....	16
Creating a Virtual Camera device (OptiTrack Server)	17
Creating a Virtual Camera device (Universal Mode).....	18
Connection Settings	19
Controllers	20
Controller Profiles	20
Profile Setup.....	20
Action Parameters	22
Virtual Camera Device Settings.....	26
MotionBuilder Camera Settings.....	28
Appendix A : Insight VCS:Pro Quick Start Guide	29
Appendix B : Insight VCS:Pro LED Identification Key	31

MOTIONBUILDER PLUGIN OVERVIEW

The NaturalPoint OptiTrack MotionBuilder Plugin is a collection of MotionBuilder devices, scripts, and samples used for working with NaturalPoint data inside MotionBuilder. The device plugins allow users to stream live data into MotionBuilder. The following diagram outlines typical MotionBuilder communication.

MotionBuilder Plugin Client/Server Architecture

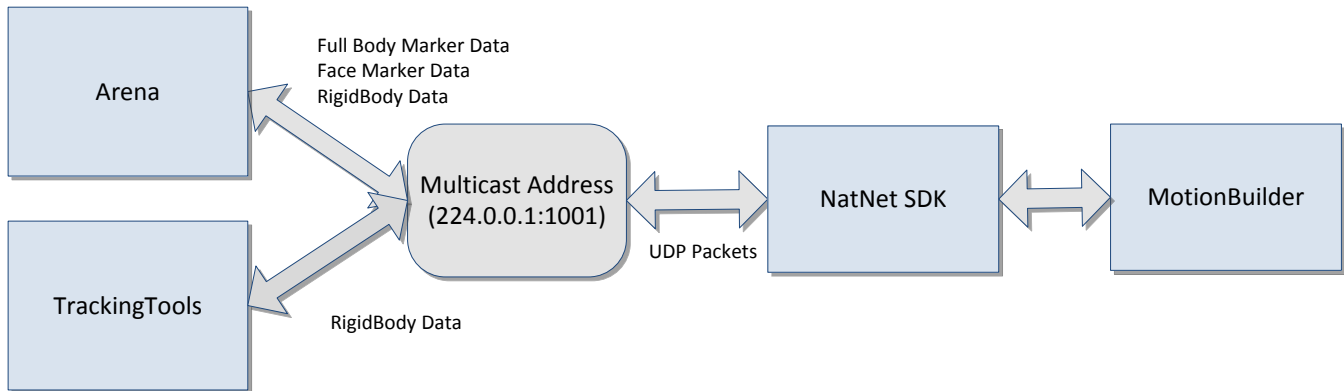

OPTITRACK OPTICAL DEVICE

The OptiTrack Optical Plugin device allows to you map motion capture (optical) data onto an animated character within MotionBuilder.

MotionBuilder Character Driven by Motion Capture Data



The OptiTrack Optical device represents a single mapping between an OptiTrack MarkerSet and a MotionBuilder Actor. To create this device, simply drag the OptiTrack Optical from the Motion Builder Asset Browser into the Viewer window or Scene browser.

Once you have created an OptiTrack Optical device, you can adjust its settings and connect it to both an OptiTrack Server (e.g. Arena) and a Motion Builder Actor.

Optical Device Interface

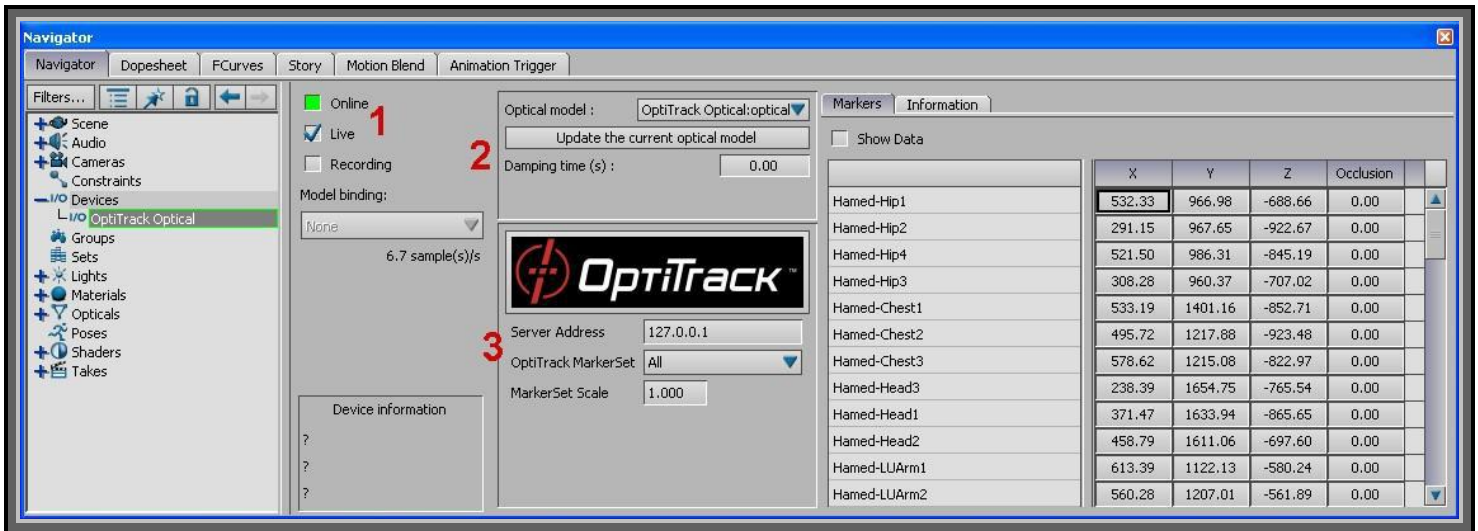

1. Device Settings The standard MotionBuilder Device Settings dialog.

Online	Click this box to connect to the OptiTrack Server (e.g. Arena). Red Not connected Yellow Connected, not streaming Green Connected and streaming
Live	Indicates to MotionBuilder that data is coming from a live source (checked) or from a recorded take.
Recording	Indicates to MotionBuilder that data from this device should be recorded when MotionBuilder is recording.
Model Binding	Unused
Device Information	Information about the status of the connection

NOTE: FOR MORE INFORMATION ON DEVICE SETTINGS, PLEASE REFER TO THE MOTIONBUILDER HELP.

2. Optical Model Sets the mapping between a Mocap marker set and a MotionBuilder "opticals" set.

Optical Model	Specifies the MotionBuilder "Opticals" model to map the markers to.
Generate a new Optical model / Update the current optical model	Adds/updates the current MarkerSet from OptiTrack to list of MotionBuilder "Opticals" model.
Damping Time	Device damping time.

3. Global Settings

Server Address	IP address of the OptiTrack Server. Use the local loopback (127.0.0.1) address if the server application is running on the same machine. Note! Be sure to configure any Firewall software first! (either disable or permit MotionBuilder as an exception)
OptiTrack MarkerSet	The name of the OptiTrack MarkerSet this optical is binding to.
MarkerSet Scale	The global scale factor to be applied to the marker data before mapping to the actor.

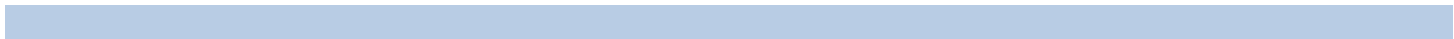

The following is a quick, step-by-step process for streaming marker data from Arena into MotionBuilder

Arena Streaming Step-by-Step

Step	Details
[Arena] Configure Arena for Streaming Data	<p>From the Arena Streaming Pane:</p> <ul style="list-style-type: none"> • Select an IP address to stream from. • Select Streaming -> Start Streaming Button <p>Note! Be sure to configure any Firewall software first! (either disable or permit MotionBuilder as an exception)</p>
[Mobu] Create an OptiTrack Optical device	<p>In the MotionBuilder Asset Browser Window -> Devices window. You should see:</p> <p>OptiTrack Optical</p> <p>Within MotionBuilder, drag the OptiTrack Optical device into the Navigator (or Viewer) pane. An instance will be created under the 'Devices' node</p>
[Mobu] Connect Optical Device to Arena	<ul style="list-style-type: none"> • In the Navigator window, select OptiTrack Optical from the Devices node • On the OptiTrack Optical pane, set the IP address of the OptiTrack server (e.g. Arena). • Click on the 'Online' checkbox - it should change from red to yellow (or green if data from the OptiTrack Server is currently streaming)
[Mobu] Create a MarkerSet -> Optical Mapping	<ul style="list-style-type: none"> • In the 'OptiTrack MarkerSet' Dropdown, select the name of a currently defined MarkerSet in Arena. • Press the 'Generate new optical model' button • In the Navigator window, under the 'Opticals' node, you should see a new the marker list. This indicates the plugin has successfully retrieved the marker list from the OptiTrack server. You should also see the Optical displayed in the viewer window if the Server is currently streaming.
[Mobu] Begin streaming marker data	<ul style="list-style-type: none"> • From Arena, start live capture or data playback • From MotionBuilder, ensure the "Viewer" window is active (Mobu will not update otherwise) • The marker set should be animating in the Mobu Viewer window • The Mobu 'online' check boxes should be green, indicating data is live and actively streaming



RECORDING OPTICAL DATA

The OptiTrack Optical device can record optical data to the current MotionBuilder take. The following step-by-step procedure can be used to record data:

Step	Details
Enable Optical Device for recording	[Mobu] -> Optical -> Check "Recording"
Start Recording	<ul style="list-style-type: none">• [Mobu] -> Transport Control -> Record (Create new take)• [Mobu] -> Transport Control -> Play (start recording frames)• [Mobu] -> Transport Control -> Stop

PLAYING BACK RECORDED DATA

The OptiTrack Optical device can be used show live data or blend live data with a recorded take. To playback recorded optical data, you need to tell MotionBuilder to disable live streaming.

Step	Details
Disable Live streaming	[Mobu] -> Optical -> Uncheck Recording [Mobu] -> Optical -> Uncheck Live
Playback recorded take	[Mobu] -> Transport Control -> Rewind [Mobu] -> Transport Control -> Play

MOTIONBUILDER ACTOR / CHARACTER SETUP

The following guide is provided as a simplified process for working specifically with Arena software. It is not the only process. For the latest information on setting up and configuring MotionBuilder Actors and Characters, please refer to your **MotionBuilder documentation**.

To animate characters in MotionBuilder, you need to create the following data flow (or "mapping"):

Mocap Marker Data -> MotionBuilder "Actor" -> Skeleton Data -> MotionBuilder "Character"

The ***Mocap Marker Data -> MotionBuilder "Actor"*** step maps Motion Capture data (Markers) to the MotionBuilder Actor object. The MotionBuilder Actor object is a skeleton solver that creates joint angles from Marker data.

The **MotionBuilder “Actor” -> Skeleton Data -> MotionBuilder “Character”** step is specific to MotionBuilder, and maps the MotionBuilder Actor skeleton onto your final character skeleton. This step requires a “rigged” character. Refer to the MotionBuilder help for detailed information on this process.

ACTOR SETUP (MOCAP MARKER DATA -> MOTIONBUILDER “ACTOR”)

You can either create a new marker map from scratch, or save time by importing an existing marker map.

Create Marker Map from Scratch

1. Create OptiTrackMB Optical device
2. Connect to Arena
3. Generate Optical
4. Stream a frame of T-Pose data from Arena
 - a. You should see the Optical in the MotionBuilder 3D viewer
5. Create MB Actor
6. Fit MB Actor to Optical
7. Create an Optical -> MarkerSet -> Actor mapping:
 - a. Import existing mapping
 - i. Actor -> MarkerSet -> Import -> OptiTrack HIK file
 - ii. Drag all opticals (incl root) onto Actor’s “Reference Cell”
 - b. Create a new mapping:
 - i. Actor -> MarkerSet -> Create
 - ii. Drag individual opticals to Actor segments
8. Activate Actor (Actor -> Activate)
 - a. Actor snaps to marker cloud pose
 - b. Actor should now be animating in Viewer

Import Existing Marker Map (from File)

Option 1: Restore MarkerSet from HIK file

1. [Mobu] Import MarkerSet definition (.hik file)
2. [Mobu] Connect to Arena
3. [Mobu] Generate Optical
4. [Arena] Stream a T-Pose frame of data into MotionBuilder
5. [Mobu] Actor Panel : Drag Opticals to Actor Markers (Actor Prop Sheet -> Reference)
6. [Mobu] Activate Actor (Actor -> Activate)
 - a. Actor snaps to marker cloud pose
 - b. Actor should now be animating in Viewer

Option 2: Export FBX from Arena

1. [Arena] Export skeleton as FBX
2. [Mobu] Merge FBX from Step 1 (File -> Merge)
3. [Mobu] Connect to Arena
4. [Mobu] Generate Optical
5. [Arena] Stream a T-Pose frame of data into MotionBuilder
6. [Mobu] Actor Panel : Drag Opticals to Actor Markers (Actor Prop Sheet -> Reference)
7. [Mobu] Activate Actor (Actor -> Activate)
 - a. Actor snaps to marker cloud pose

- b. Actor should now be animating in Viewer

CHARACTER SETUP (MOTIONBUILDER ACTOR -> CHARACTER)

1. Do Actor Setup (Above)
2. Import a rigged skeleton (File -> Merge -> Skeleton)
3. If skeleton is not “characterized, characterize it:
 - a. Create MB Character (Drag onto skeleton “hips”)
4. Map Character to Actor
 - a. Select Character -> Character Settings -> Input Type -> Actor Input
 - b. Check “Active”
5. Activate Actor (Actor -> Activate)
 - a. Skeleton and Actor should now be animating in Viewer

Note! For more information on setting up and configuring MotionBuilder Actors and Characters, please refer to your MotionBuilder documentation.

VIRTUAL CAMERA DEVICE (INSIGHT VCS)

The Virtual Camera device is specifically designed for creating a Virtual Camera in MotionBuilder. You can use the Insight VCS device with standard OptiTrack applications such as Arena and Tracking Tools, or you can use the device in "Universal" mode, which works with generic MotionBuilder Optical or RigidBody objects, allowing you to use the Insight VCS device with alternative motion capture systems that support optical or rigid body devices in MotionBuilder.

Camera Tracking in MotionBuilder

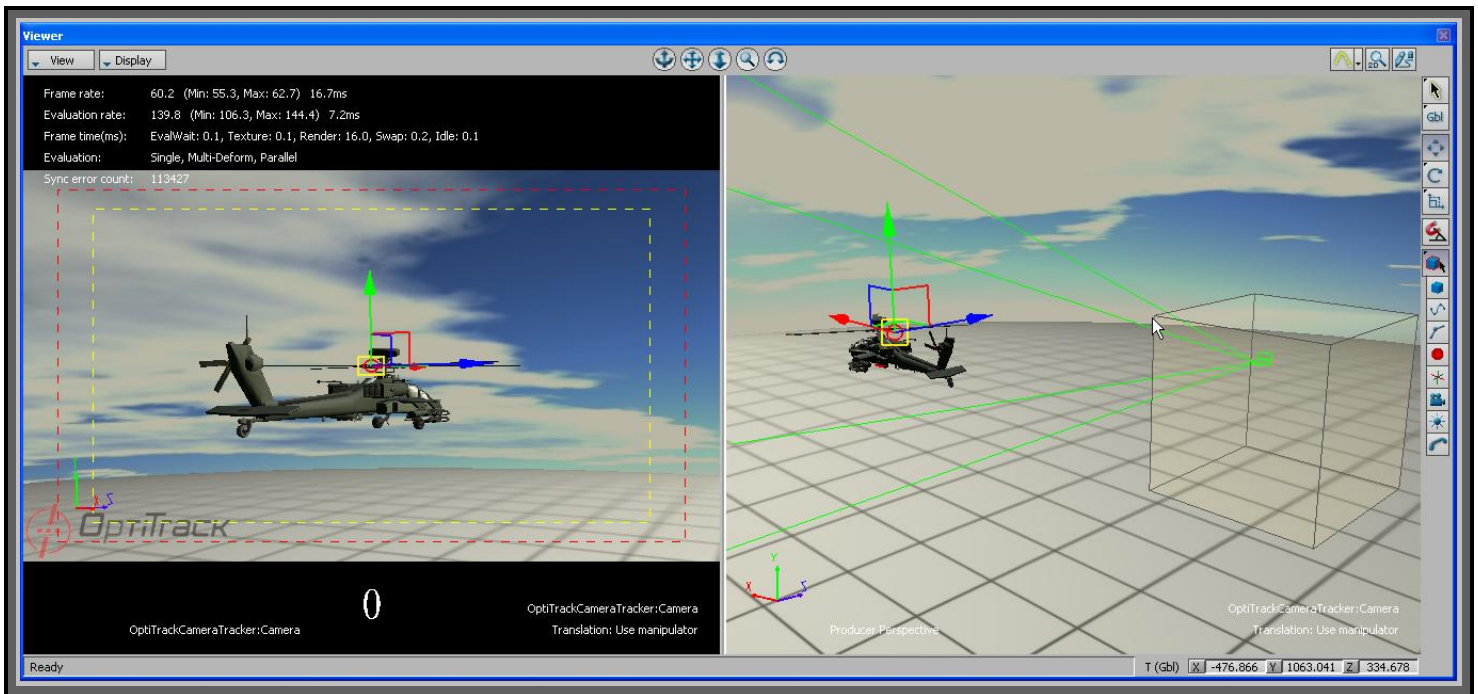

The Virtual Camera Device provides a robust camera tool supporting typical camera movements:

Insight VCS Features

Pan / Dolly / Boom	Use VCS controls to Pan Left/Right and Up/Down. Pan in local, world, or a combination of coordinate systems. Adjust pan speeds on the fly with controls or scripts.
Pitch / Tilt / Roll	Absolute orientation at all times from the OptiTrack optical system.
Free Move	Absolute position at all times from the OptiTrack optical system. Scale movement in real-time with controllers or from script.
Zoom	Fully control camera zoom / FOV and zoom rates using the controller's analog thumbsticks and speed adjusters.
Smooth	Advanced Kalman filtering allows for customizing a "steadicam" feeling.

Play / Record	Control common actions like recording and playback using the controller.
Custom commands	Customize the controller by mapping controller inputs to execute scripts for complete control and one-person camera operation.

The Virtual Camera also integrates into existing MotionBuilder camera control workflows, including spline/path/constraint animation and custom scripted behaviors.



SUPPORTED PLATFORMS

The Insight VCS Plugin is currently supported on the following MotionBuilder versions:

Windows

- o MotionBuilder 2010 32-bit and 64-bit
- o MotionBuilder 2011 32-bit and 64-bit

INSTALLATION

1. Run the MotionBuilder Plugin installer, following the instructions.
2. To confirm installation - the plugin should appear in the MotionBuilder Asset Browser under devices.

LICENSING

The VCS:Mobu plugin requires a valid license to run. There are two versions of the Insight VCS:Mobu plugin:

Standard: For user's with OptiTrack motion capture equipment and applications (e.g. ARENA™ or Tracking Tools).

Universal: For user's with 3rd party motion capture equipment. This version works with any MotionBuilder Rigid Body.

Each version has its own licensing requirement:

Insight VCS Licensing Requirements

Product	Licensing	Requires Unique Hardware Key
VCS:Mobu Standard	VCS:Mobu license is installed into the OptiTrack Server Application's (e.g. ARENA™ or Tracking Tools) license folder. The server application administers the license to the plugin during connection.	No - uses Server Application's key.
VCS:Mobu Universal	VCS:Mobu Universal license is installed into the local workstation's (system running MotionBuilder) OptiTrack license folder, and requires a hardware key.	Yes.

Please refer to your order confirmation and/or Quick Start Guide for specific licensing instructions.

Additional information on licensing can be found in our **Licensing and Activation FAQ**:

<http://www.naturalpoint.com/optitrack/support/activate/faq.html>

CREATING A VIRTUAL CAMERA DEVICE (OPTITRACK SERVER)

1. [OptiTrack Server App] Create a Rigid Body from your tracking controller's markers. **When you create the Rigid Body, be sure to orient your tracking controller down the OptiTrack Server Application's +Z axis.** This will be the camera's "Neutral" position.
2. [OptiTrack Server App] Enable network streaming (make sure rigid body data is streaming).
3. [MotionBuilder] Drag the OptiTrack Insight VCS device from the Motion Builder Asset Browser Panel into the Viewer or Navigator window.
4. [Insight VCS Panel] Connect to an OptiTrack Server (e.g. Arena, TrackingTools) by clicking the "Online" checkbox. If the connection was successful and data is streaming from you OptiTrack server application, this box will change from Red to Green.
Note! Be sure to configure any Firewall software first! (either disable or permit MotionBuilder as an exception)
5. [Insight VCS Panel] Create a new MotionBuilder camera using the Model Binding dropdown.
6. [Insight VCS Panel] [Optional] If tracking more than one rigid body object in your OptiTrack server application, select the rigid body you wish to use as your tracking source using the Rigid Body ID dropdown on the CameraTracker device panel (Note: the camera tracker will automatically default to the first detected Rigid Body).

You should now see a standard MotionBuilder Camera moving within your 3D scene:

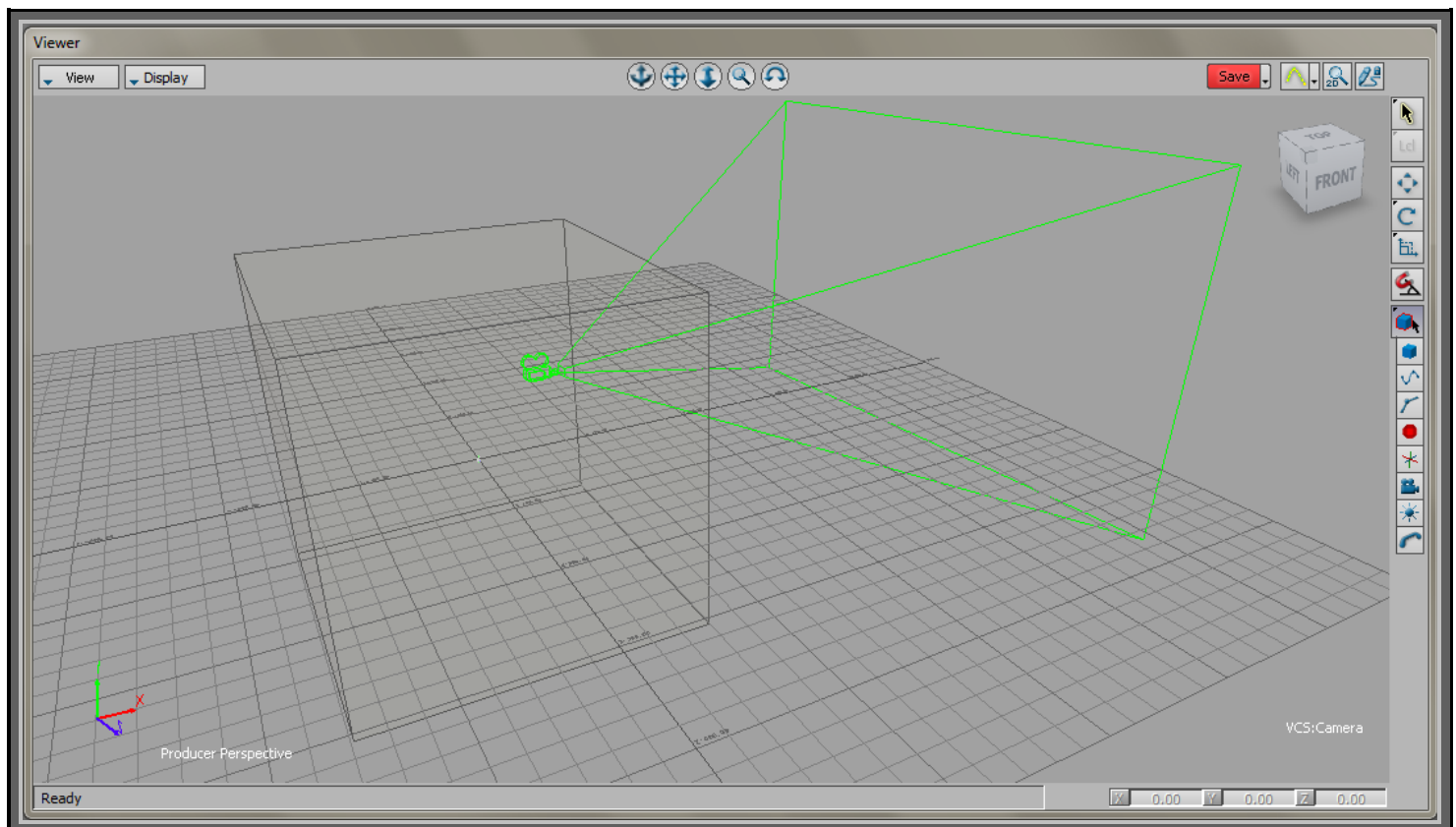

CREATING A VIRTUAL CAMERA DEVICE (UNIVERSAL MODE)

1. [MotionBuilder] Create a Rigid Body.
2. [Insight VCS Panel] Check the "Universal Connection" Radio.
3. [Insight VCS Panel] Check "Online".
4. [Insight VCS Panel] Create a new MotionBuilder camera binding using the Model Binding dropdown.
5. [Insight VCS Panel] Select the Rigid Body you created in step 1 using the Rigid Body dropdown in the Universal Connection group box.

CONNECTION SETTINGS

Virtual Camera connection settings are managed by the Main interface tab on the Virtual Camera device panel:

Insight Virtual Camera- Main Interface

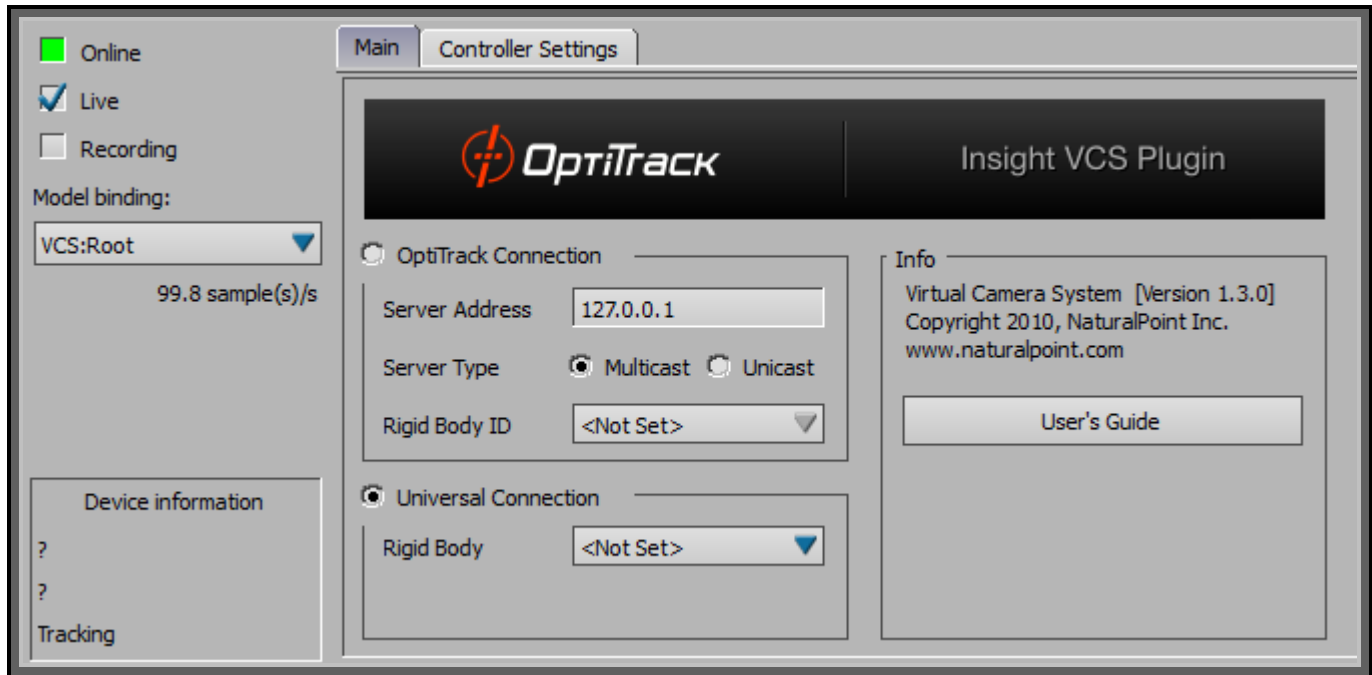

Insight Virtual Camera - Main Interface Settings

<p>Online</p>	<p>Click this box to connect to the OptiTrack Server (e.g. Arena).</p> <p>Red Not connected</p> <p>Yellow Connected, not streaming</p> <p>Green Connected and streaming</p>
<p>Live</p>	<p>Indicates to MotionBuilder that data is coming from a live source (checked) or from a previously recorded take.</p>
<p>Recording</p>	<p>Indicates to MotionBuilder that data from this device should be recorded when MotionBuilder is recording.</p>
<p>Model Binding</p>	<p>Indicates the MotionBuilder Camera object to be controlled by the tracking controller.</p>

Device Information	Information about the status of the connection.
OptiTrack Connection	Indicates the data source is an OptiTrack server application, such as Arena or Tracking Tools.
Universal Connection	Indicates the data source is a generic MotionBuilder RigidBody.
Server Address	IP Address of the OptiTrack Server
Rigid Body ID	[OptiTrack Connection] Name of the OptiTrack server application's Rigid Body to use for tracking.
Rigid Body	[Universal Connection] Name of the MotionBuilder RigidBody to use as a position/orientation source.

CONTROLLERS

The Insight VCS plugin supports any DirectInput compatible joystick or USB device. Controllers can then be configured to perform actions or control the camera using **Controller Profiles**.

CONTROLLER PROFILES

Virtual Camera controls are managed by a Control-to-Event mapping system called the **Controller Profile**. The controller profile is configured in the **Controller Tab**. The Insight VCS plugin allows you to create and swap between multiple controller profiles, allowing you to create any number of custom button/axis configurations depending upon the scene, particular move types, different physical VCS controllers or HID devices, etc.

Profiles can be saved and then later swapped out using the **Profile Dropdown**.

Profiles are saved into `<VCS Mobu install folder>\Profiles` folder .

The VCS plugin ships with 2 default profiles:

- The 2 controller VCS Pro (`<VCS Mobu install folder>\Profiles\VCSProDefault.xml`).
- The XBox based VCS Mini (`<VCS Mobu install folder>\Profiles\VCSMiniDefault.xml`).

When the Insight VCS plugin is first launched, it will attempt to detect any compatible controllers. It will then attempt to match the detected controllers with an existing **Controller Profile**, beginning with the last used ("preferred") profile.

PROFILE SETUP

The VCS plugin supports 2 types of controller inputs and 2 types of actions:

Axis Inputs / Actions: Axis inputs are analog inputs and represent the range of values. This range has been scaled to [0, 1000]. Axis inputs can be assigned to Axis actions. PTZ operations (Pan, Tilt, Zoom) are good examples of typical Axis Actions.

Button Inputs / Actions: Button inputs are the button inputs on the controller. These are “one shot” events that occur when the button is pressed. Transport commands such as Play, Record, and Rewind are typical examples of “one shot” events.

Note! Some Insight VCS controllers have a dial that is represented in the Axis list as a "Wheel". This is a special form of an axis, and can be used to modify existing actions, such as zoom speed, pan speed, and motion scale amount.

Figure 3 – A Typical Insight VCS Controller Map

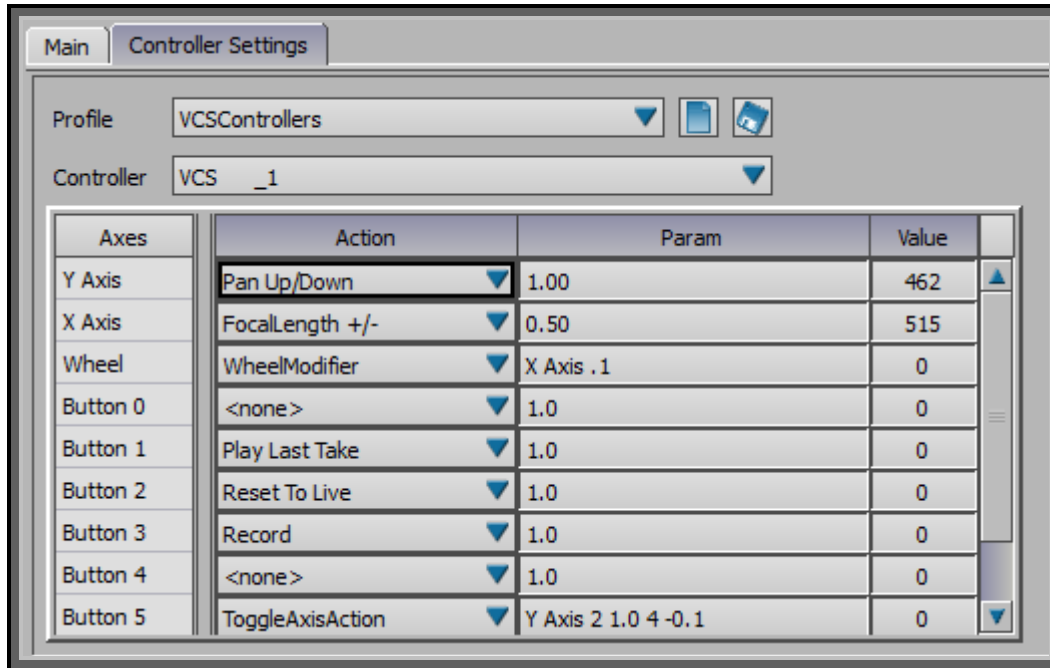

Insight VCS Inputs / Action Settings

Axes	Name of the controller’s analog input.
Action	Action to take or value to change.
Param	Input parameter used by some actions to modify the action in some way (e.g. speed up or slow down zooming).
Value	Current value of the control input.

ACTION PARAMETERS

Some actions have parameters that modify the way they operate. The following tables list the **axis** and **button** actions, and how the parameter value for that action is interpreted.

VCS controller - Axis Actions

Action	Parameter(s)	Example
Pan Right/Left	[Pan Speed] [Curve Type]	1.0 [pan at normal rate, linear curve] 1.0 1 [pan at normal rate, ease-in curve] 0.5 1 [pan at half speed, ease-in curve] 2.0 [pan at 2x speed]
Dolly In/Out	[Pan Speed] [Curve Type]	1.0
Pan Up/Down	[Pan Speed] [Curve Type]	1.0
Focal Length +/-	[Focal length change rate] [Curve Type]	1.0
Orbit Offset	[Orbit offset change rate] [Curve Type]	1.0
Focal Distance	[Focal distance change rate] [Curve Type]	1.0
Wheel Modifier	[VCS Dial controls only] Modify an axis' parameter value (e.g. zoom speed, pan speed, translation scale) by a specified increment. Format: [axis name] [increment]	Examples: X Axis .1 (+/- the X Axis parameter by 0.1) Y Axis .2 (+/- the Y Axis parameter by 0.2) Z Axis .1 (+/- the Z Axis parameter by 0.1) Scale All .5 (+/- all translational scale by .5) Translate All 1.0 (+/- all pan speeds by 1.0)
Rotate Right/Left	[Rotate Speed] [Curve Type]	1.0 [rotate at normal rate, linear curve] 1.0 1 [rotate at normal rate, ease-in curve] 0.5 1 [rotate at half speed, ease-in curve] 2.0 [rotate at 2x speed]
Rotate Up/Down	[Rotate Speed] [Curve Type]	SAME AS ABOVE
Tilt Right/Left	[Rotate Speed] [Curve Type]	SAME AS ABOVE

Curve Types

When mapping a controller thumbstick axis to an animatable camera parameter (pan, zoom), you have the option of specifying how the Insight VCS plugin should interpret controller axis movement as a standard animation curve. Instead of modifying the value over time, however, the motion curve modifies the value over the controller span, from neutral/center position (0) to maximum position (Max). The following diagram describes this relationship:

Controller value modifier curve

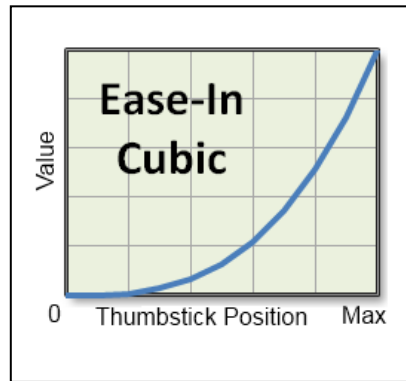

The VCS plugin offers the following built-in curve options:

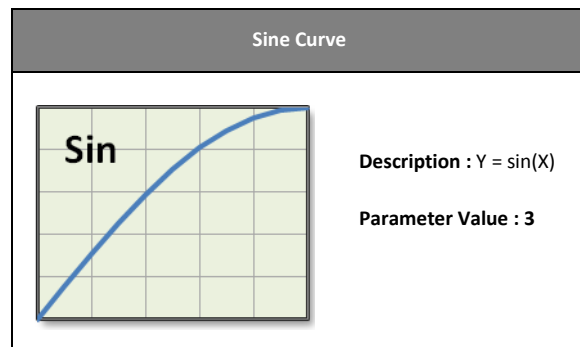
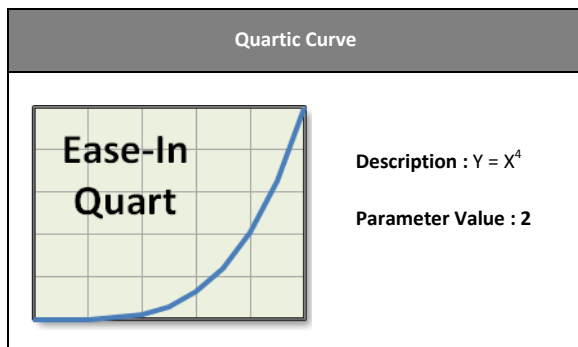
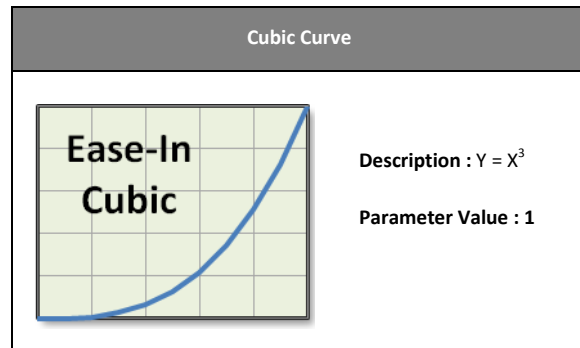
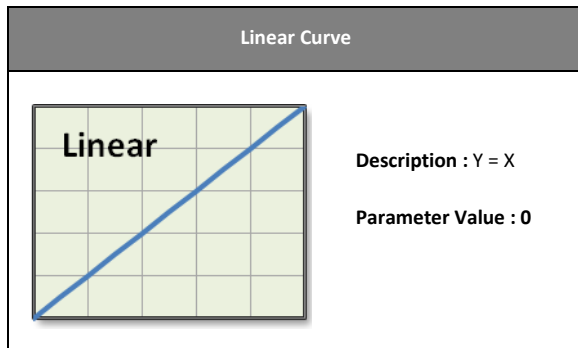

VCS Controller - Button Actions

Action	Parameter	Example
Record	Copy data from previous take?	true
Play	None	
Fullscreen	Toggles between Fullscreen and the MotionBuilder GUI. On return to the MotionBuilder GUI, this parameter indicates the number of viewports to show.	2
RunScript	Runs a MotionBuilder python script. This script must be located in your MotionBuilder scripts root folder.	ResetOffset.py
ToggleAxisAction	<p>Toggles a specified axis between 2 actions.</p> <p>[Axis name],[Action1 Index], [Action1 Params],[Action2 Index],[Action2 Params]</p> <p>The example at right toggles the Y Axis behavior between Dolly In/Out at speed 1.0 with a Cubic Curve and Focal Length at 0.1 speed with a Quartic curve.</p> <p>This action can be used to extend axis functionality without swapping profiles.</p>	Y Axis, 3, 1.0 1, 4, 0.1 2
Pause	None	
Stop	None	
Rewind	None	
Suspend Tracking	None	
Scale Translation +/-	Increment amount	.5
Scale Rotation +/-	Increment amount	.5
Zoom +/-	Increment amount	.5
FOV +/-	Increment amount	.5
Playback Speed +/-	Enumerated value that matches Mobu transport	2
Reset Zoom	Focal Length to reset to	50.0

ResetOffset	[x y z] Optional - specifies the position to reset camera to, otherwise camera is reset to (0.0,0.0,0.0)	10.0 10.0 0.0 [reset camera offset to 10,0,0]
Reset Rotation Offset	[x y z] Optional - specifies the rotation vector to reset to (in degrees), otherwise camera is reset to (0.0,0.0,0.0)	0.0 90.0 0.0 (reset camera to 90 degrees yaw)
Reset Orbit Offset	None	
Change Camera	None	
Play Last Take	None	
Reset To Live	None	

The Insight VCS plugin has several properties that can be used to customize its behavior. These properties can be accessed in the same manner as any other MotionBuilder object property, such as from the Asset Browser or from MotionBuilder's Python scripting environment.

Figure 4 – Insight VCS Properties

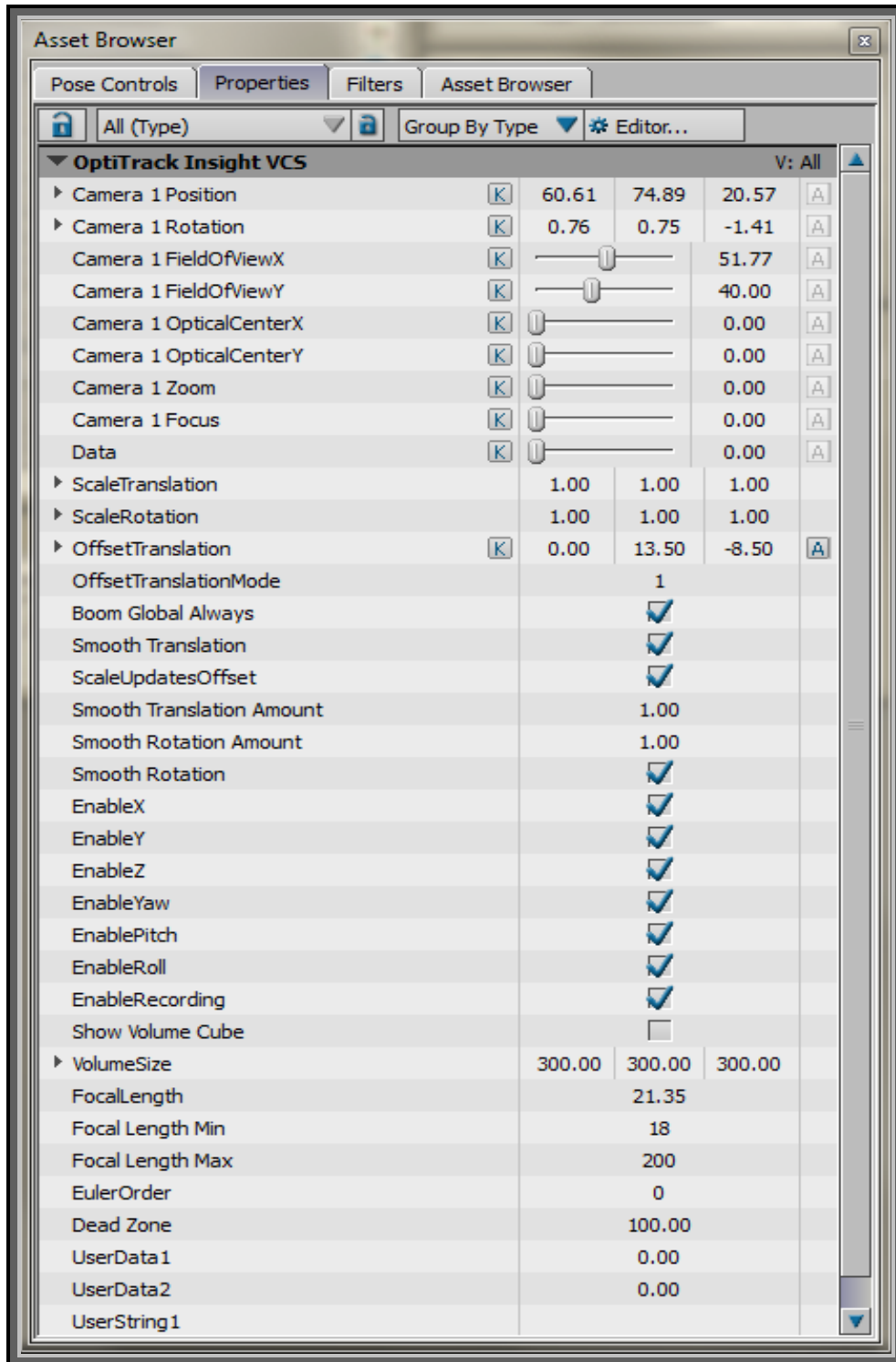

Insight VCS Properties

Action	Parameter
Scale Translation	Scale the physical movement (when tracking controller is moved).
Scale Rotation	Scale the physical rotation (when tracking clip is rotated).
Offset Translation	<p>Can be used for 2 purposes :</p> <ol style="list-style-type: none"> 1. To adjust the center of the physical volume to the virtual scene. 2. To effectively pan/truck/dolly the camera. This value is updated by the thumbstick controls for the Pan/dolly/truck operations
OffsetTranslationMode	<p>Affects how Offset Translation is applied to the camera:</p> <p>0 : Global Translates the camera according to the MotionBuilder global coordinate system (global).</p> <p>1 : Local Translates the camera according to the camera's coordinate system (local).</p> <p>2 : LocalOnStart Translates the camera according to the camera's coordinate system when the camera first moves (stick first moves), then keeps that axis (Does not continuously update the coordinate system).</p>
Boom Global Always	Always pan camera up/down in the global Y axis, regardless of the OffsetTranslationMode
Scale Updates Offset	Instructs whether changes to Scale Translation update the Offset Translation value in order to keep the camera in the same position (true) or does not affect Offset Translation, resulting in camera position moving to new scaled amount.
Smooth Translation Amount	Applies smoothing to the camera position values.
Smooth Rotation Amount	Applies smoothing to the camera rotation values.
Dead Zone	Controller thumbsticks do not typically restore to an exact center value. Dead Zone can be used to specify a value range around thumbstick center that should be ignored. This can be used, for example, to prevent drift in pan/dolly/zoom when thumbsticks are mapped to these actions.

MOTIONBUILDER CAMERA SETTINGS

A MotionBuilder Camera controls how you see the 3D scene. MotionBuilder's Camera object allow users the ability to model real-world cameras, including settings such as Focal length, aspect ratio, film format, etc.

Refer to the MotionBuilder documentation for more information on Camera Settings.

APPENDIX A : INSIGHT VCS:PRO QUICK START GUIDE

1. Review Components & Assemble Rig

The following Insight VCS:Pro items are included:

Rig Components

- 1 x microShoulderMount Deluxe Bundle
- 1 x microMount
- 1 x microHandle
- 2 x 8" Grip Rod w/ clamp
- 2 x 4" Grip Rod w/ clamp
- 1 x VCS HD Monitor
- 2 x VCS USB Joystick
- 1 x VCS Mux assembly
- 1 x VCS Demux assembly

Cables

- 1 x 50' or 100' custom 15-pin VCS cable
- 1 x 36V power brick/cable
- 1 x 5m A to B USB Uplink cable
- 1 x 10' DVI-HDMI cable
- 2 x 24" MiniUSB B Up Angle USB cable
- 1 x DC Plug Cable, 2.1mm, 24"
- 1 x 18" HDMI M / M cable

Markers and Posts

- 1 x VCS Markers & Posts
- 4 x Reflective Marker : 7/16" Hard
- 1 x 40mm mounting post
- 2 x 60mm mounting post
- 1 x 80mm mounting post



VCS Mux assembly

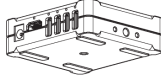

VCS Demux assembly

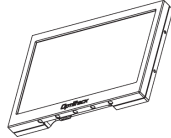

VCS HD Monitor

Note: The VCS Mux should sit near the PC. The USB, DVI-HDMI and power cables go to/from the Mux and PC. The Demux assembly is attached to the rig. See rig diagrams at right.

2. Connect Cables

Connect the 50' or 100' custom 15-pin VCS cable to the Mux and Demux BEFORE connecting any other cables. Then apply power and connect Mux to PC and Demux to assembled VCS:Pro rig. See diagrams at right.

3. Setup Monitor & Video Display

The HD monitor has five buttons on the back. You may need to select HDMI input for proper display, using the SEL button (second button from the bottom).



Based on your software/usage preferences, you can choose to extend or duplicate your Windows desktop onto the VCS:Pro's HD LCD display screen (using Display Properties in Windows).

Native resolution of the VCS:Pro's HD LCD display is 1280x768, but the resolution can be scaled up to 1920x1080. If you are duplicating your desktop, you will want to match your primary PC monitor's resolution to one of these two dimensions.

On the side of the Demux there is a rotary switch, with settings from 0 to 7, to set the gain for the video. The default setting will typically result in minimal gain (noise). However, when the system is used with a 100' 15-pin cable, the gain switch might need to be adjusted to improve video quality.

* Rig Configurations

The orientation of the VCS:Pro rig components can be adjusted to fit your body and shooting style.

(See back page for marker configurations.)

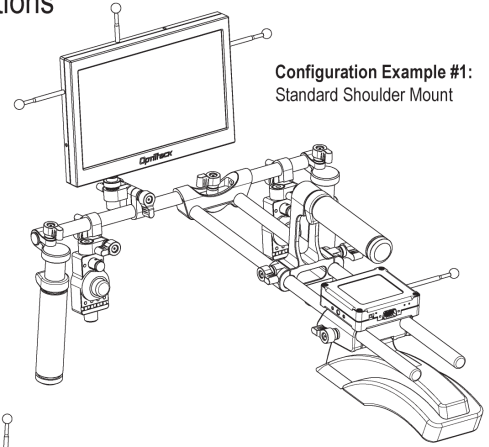

Configuration Example #1:
Standard Shoulder Mount

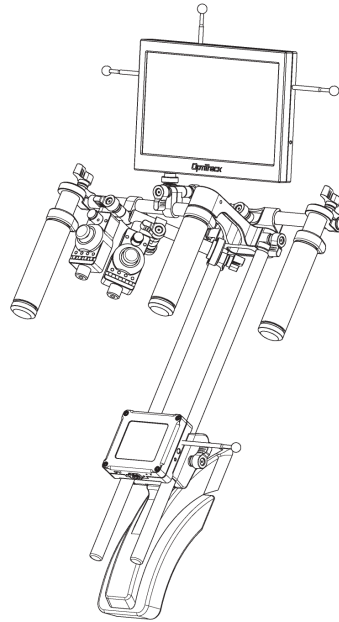

Configuration Example #2:
Low Profile / Down Low

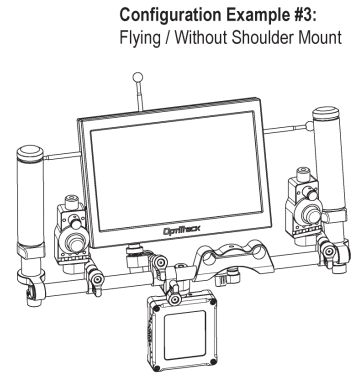

Configuration Example #3:
Flying / Without Shoulder Mount

* Marker Configurations

The VCS:Pro rig needs four markers total. Place one marker on top of the HD monitor and one on either side.

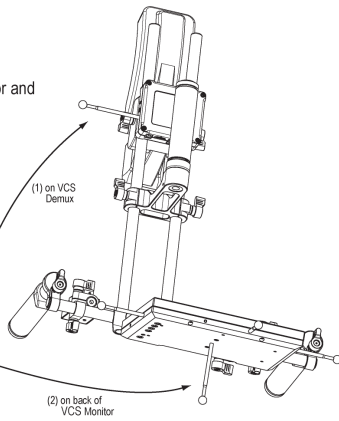
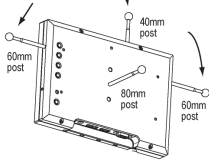

The fourth (80mm) marker may be placed in either of these two locations.

4. Software Compatibility & Usage

Windows 7 is preferred. Windows Vista and XP operating systems are supported.

The Insight VCS system is intended for use with NaturalPoint's MotionBuilder and Maya VCS plugins. Buttons and joysticks can be mapped for extensive camera control. See the MotionBuilder and Maya plugin manuals at OptiTrack.com for additional information.



Friendly Customer Service

If you have any difficulties after reviewing the documentation, visit our website or call 1.541.753.6645 between 9AM-5PM PT.

Visit www.OptiTrack.com for the latest software support, sample code and product news.

OptiTrack.com

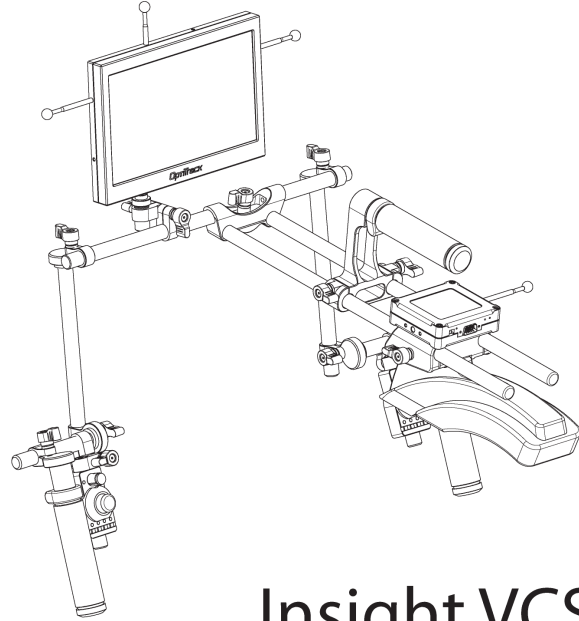

Insight VCS:Pro quick start guide

APPENDIX B : INSIGHT VCS:PRO LED IDENTIFICATION KEY



* Insight VCS:Pro LED Identification Key: Mux

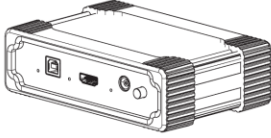

VCS Mux assembly

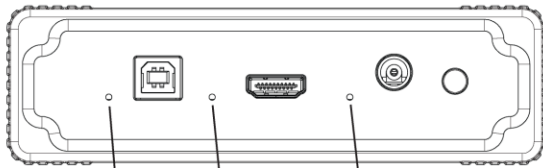

Green LED Green LED Red LED

Uplink-USB (Mux and Demux) connection is good

HDMI connection from PC detected

36V Power has been applied to the DC Power Jack

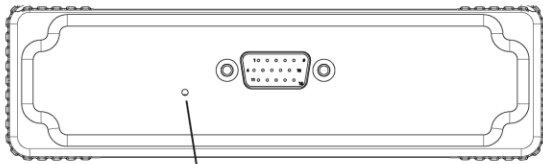

Blue LED

Valid connection to Demux detected

P-OT-109.1102

© 2011 NaturalPoint, Inc. All rights reserved. All other company and or product names are the trademarks of their respective owners.

* Insight VCS:Pro LED Identification Key: Demux

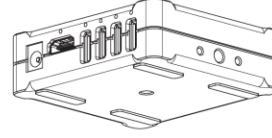

VCS Demux assembly

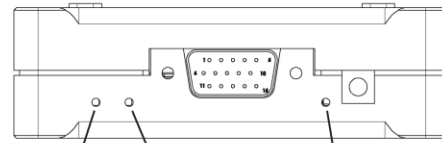

Green LED Blue LED Red LED

USB Hub detected by PC - hub is now active

HDMI connection from Mux detected

Power from Mux detected

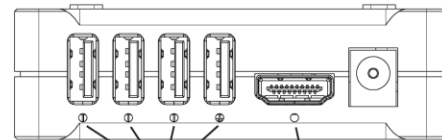

Yellow LEDs Green LED

Downlink-USB port is active

HDMI connection to Monitor detected

P-OT-109.1102

© 2011 NaturalPoint, Inc. All rights reserved. All other company and or product names are the trademarks of their respective owners.